



www.casambi.com



Casambi Knowledge Base



Download FREE Casambi
iOS/Android App



Specification Library

Project: _____

Reference Type: _____

Item Code: _____

Date: _____

Notes: _____

2-Button Wireless Occupancy Sensor With Dimming

Overview

- Passive Infrared (PIR) Occupancy Sensor
- Two Buttons
- Casambi Wireless Mesh
- Manual on/off (wireless)
- ioXt Alliance Cybersecurity Certification
- Dim up/down (wireless)
- LED Status Indicator Light
- Mounts in any Standard Wall Box
- Color: White



Suitable for Indoor Use Only



Applications

mwConnect's two button wall control with automatic occupancy/vacancy detection (PSC-DM-I-WS-200-BLE-CB) communicates with Casambi Wireless mesh network devices to provide lighting control for a variety of indoor applications. It can be mounted in any standard single-gang wall box.

PIR detection is best suited for areas with clear line of sight. Typical applications include classrooms, copy rooms, private offices, conference rooms, and private restrooms.

Typical applications include public restrooms, private offices, classrooms, conference rooms, storage spaces, and break rooms.

Operation

Casambi Wireless Mesh Controls:

The sensor connects to a wireless mesh network via a mobile app, available as iOS or Android, to allow initial setup and subsequent parameters adjustments.

User Interface: Using the mobile app, features include: setup, control real time feedback, and scheduling without a gateway or internet access.

Advanced Features: Buttons can be programmed using the mwConnect Casambi Mobile App to assign advanced features. On, Off, Raise/Lower, Scenes, Groups, Color Tuning, Sequencing, Light Animations. See page 3 for more details.

See the mwConnect Casambi Commissioning User Manual for more information.

Summary

Sensor Type:
PIR Occupancy/Vacancy Sensor Dimmer

Input Voltage | Power Consumption:
120-277 VAC, 50/60Hz | Max 1.5W

Mounting:
Standard wall box

Max Range:
40 ft @ 4ft mounting height
(12.2m @ 1.2m mounting height)

Max Wireless Range¹:
30ft (9.14m)

Operating Temperature:
0° to 55°C

Storage Temperature:
-10° to 60°C

Relative Humidity:
90-95% non-condensing at 30°C

Color: White

Warranty: 5 years

Note:
1. Wireless Range is highly dependent on the integration of fixtures, surrounding environment and conditions. It is recommended to conduct testing for range accuracy.



www.casambi.com



Casambi Knowledge Base



Download FREE Casambi
iOS/Android App



Specification Library

Project: _____

Reference Type: _____

Item Code: _____

Date: _____

Notes: _____

Physical Dimensions

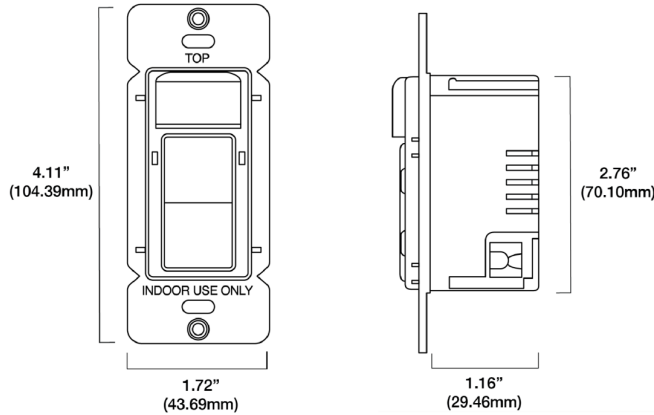

Wiring Diagram

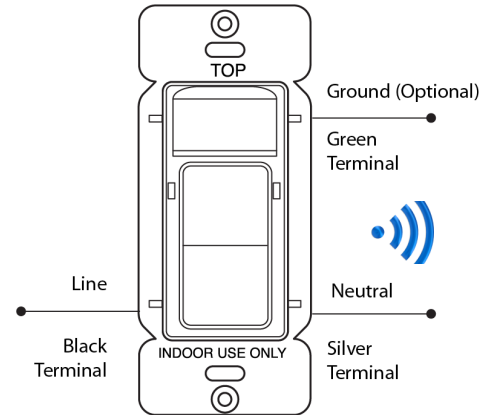

Example

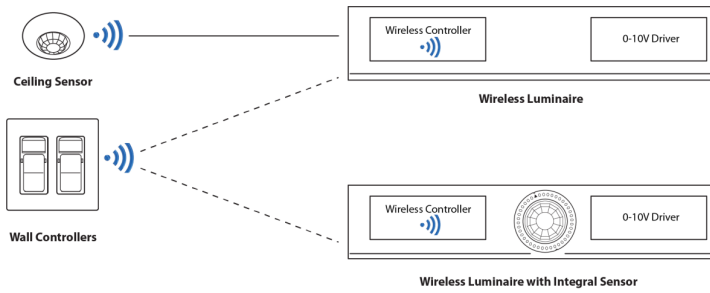

Detection Area

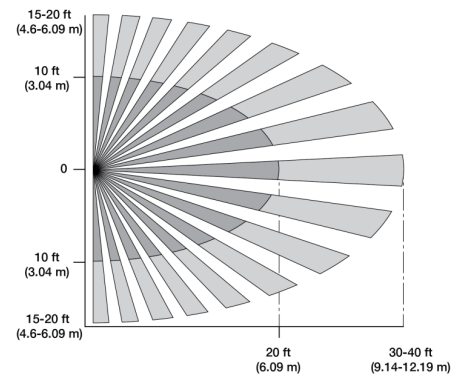

Drawings are not to scale

Wireless Manual Control

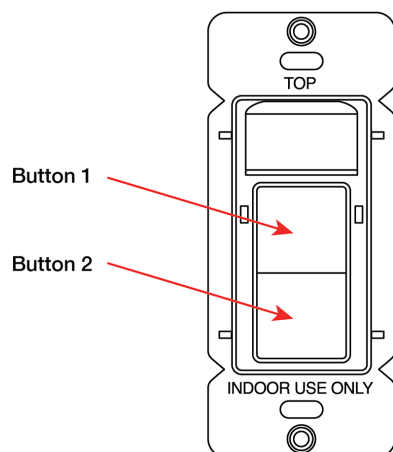

On/Off Control

Button 1 for On:

Short press - ON/Auto*

Button 2 for Off:

Short press - OFF

*Auto = Resume automatic control; turns on the automatic settings for luminaires (defined by the settings profile).

For Dimming:

Button 1 for Raise:

Press and Hold - RAISE

Button 2 for Lower:

Press and Hold - Lower

Factory reset:

Hold both Button 1 and Button 2 for 10 sec. The device returns to an un-provisioned state.



www.casambi.com



Casambi Knowledge Base



Download FREE Casambi iOS/Android App



Specification Library

Project: _____

Reference Type: _____

Item Code: _____

Date: _____

Notes: _____

Advanced Programming Button Functions

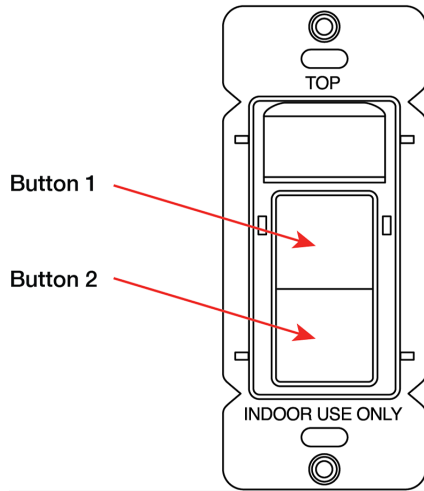

The **PSC-DM-I-WS-200-BLE-CB** buttons can be programmed using the mwConnect Casambi Mobile App to assign advanced features:

Buttons can be assigned to control: (see users guide for more)

- A Luminaire (a fixture).
- A zone (a group of Luminaires to be controlled together).
- An area (a group of groups).
- A scene (group 1 @100%, group 2@50%, group 3@15%).
- All Fixtures

Toggle: If you set a button as a toggle you turn on or off any of the above functions. If you turn off the toggle mode then LATP (last action or button press takes precedence).

Animation: Dynamic Scenes or Cycle Scenes

Playback multiple scenes, with adjustable time (fade time), how long the scenes are on (wait), the time transitioning of the scenes (fade), the order of the scenes, repeat. You can have the animation run until you turn off with the switch. Or you can start or stop using the time schedule function.

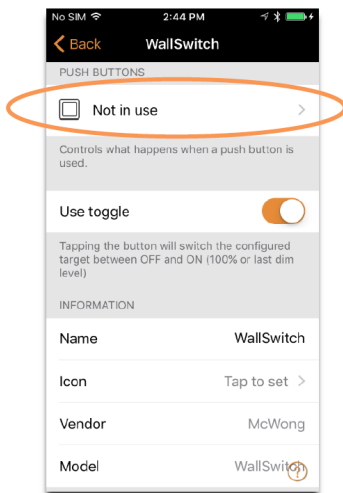

Configuring switch button

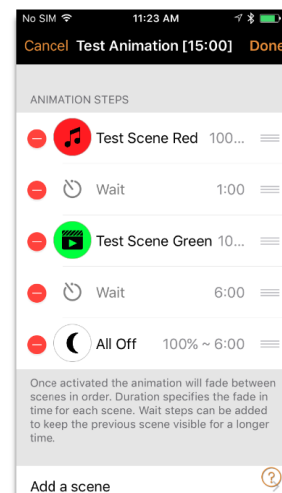

Animation example

How to Order

Model No.	Description	Input Voltage
PSC-DM-I-WS-200-BLE-CB	Wireless PIR Occupancy Sensor Two Button Dimming Wall Controller, Casambi Wireless Mesh, (decorator faceplate not included)	120-277 VAC, 60Hz